

Vibration Control of Piping Systems

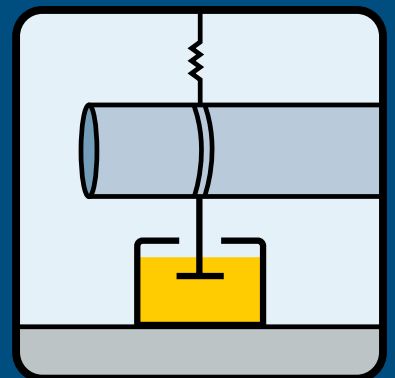

Vibration Control of Piping Systems

Typical GERB pipework damper



Pipework dampers are frequently used for the protection of piping systems and other components in power plants and industrial facilities. GERB pipework dampers are highly effective viscoelastic elements, well proven in numerous installations. Already in 1951 Viscodampers® were patented for pipe applications.

Practical experience in power plants shows that the reliability and life expectancy of piping systems are largely determined by their dynamic characteristics and behavior. Dynamic loads are experienced during normal, continuous operation and during abnormal, potentially disastrous situations.

Hydrodynamic forces and pressure pulses, i.e. due to abrupt opening or closing of valves, cause vibrations of piping and aggregates as do connected pumps, compressors, or turbines. In addition, external excitations caused, for example, by disastrous events like earthquakes may be transmitted to the piping through the support structure. In all cases the resulting pipe deflections can be excessive and permissible loads may be exceeded.

As piping systems have only small internal damping, dynamic excitations are especially critical when frequencies match the natural frequencies of the piping system. In such cases piping motions may be amplified due to resonance effects. But also operational vibrations with relatively small deflections can cause material fatigue and pipe damage.

Based on the experience in design and application of Viscodampers® for vibration control of machinery and structures, an element was created that shows several advantages compared to other standard pipe supports:

- GERB pipework dampers reduce vibrations in all degrees of freedom.
- GERB pipework dampers develop high damping forces in case of shock loads, whereas slow motions are not hindered.
- GERB pipework dampers reduce operational vibrations by selectively increasing system damping.
- GERB pipework dampers react to vibrations immediately without delay or time-lag.
- GERB pipework dampers are simple in design and handling und therefore cost-saving. There are no parts of wear and tear, and they are maintenance-free.

GERB pipework dampers consist of three components:

- the damper housing,
- the damping fluid, and
- the damper piston, which is immersed in the fluid, and which can move in all directions up to the damper walls.

The damping forces result through shearing and displacing of the damping fluid. The damping effect is nearly velocity proportional.

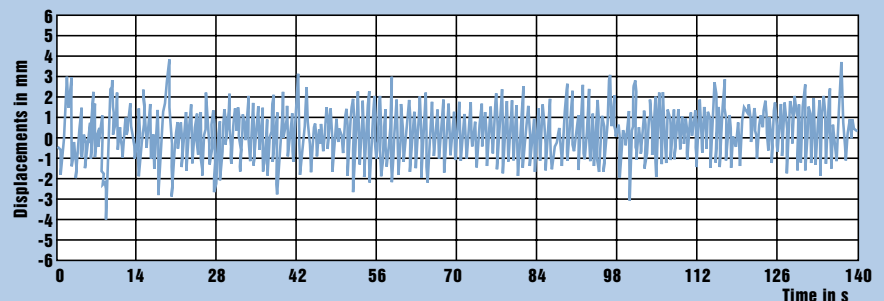

Pipe vibrations without (see above) and with GERB pipework dampers (see below)

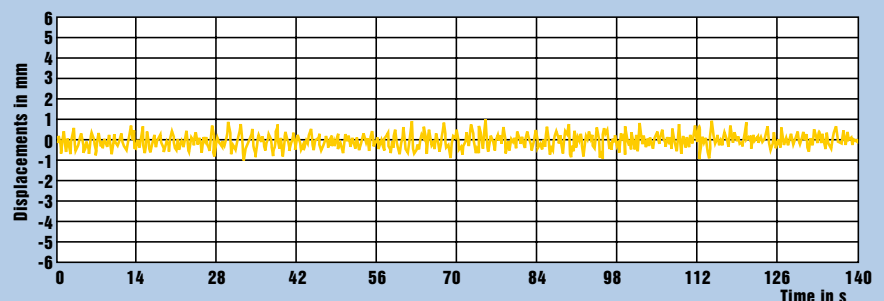

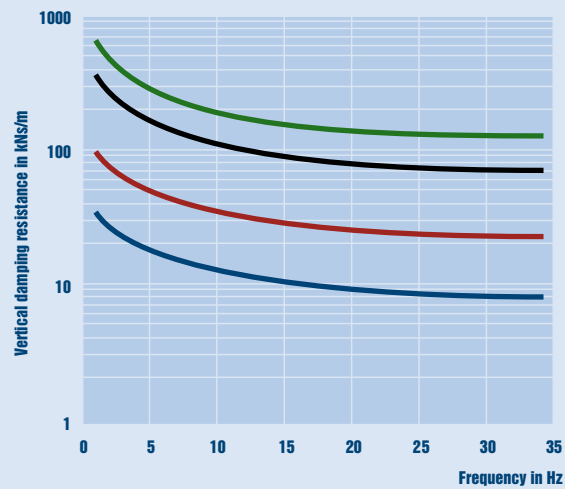
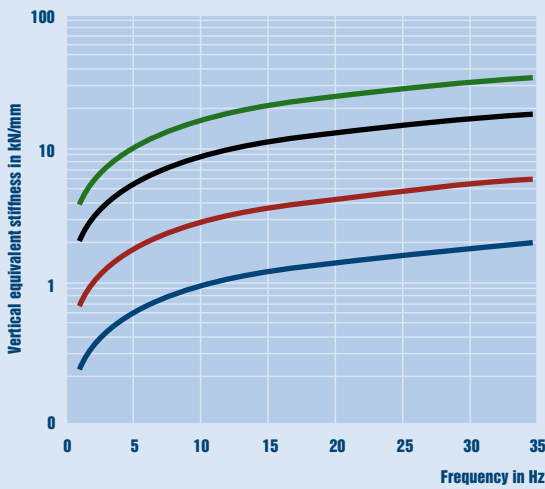

Typical curve of vertical equivalent stiffness and damping resistance of GERB pipework dampers

There are several characteristics, which may be used for the design and the selection of GERB pipework dampers:

- Nominal load [kN]
- Vertical and horizontal damping resistance [kNs/m]
- Vertical and horizontal equivalent stiffness [kN/mm]
- Vertical and horizontal permissible displacements [mm]
- Operating temperature [°C]

The **nominal load** is the maximum force of the damper at operating temperature.

The **damping resistance** is defined as the ratio between maximum damping force and maximum velocity. This value is frequency dependent and describes best the dissipative properties of the viscous elastic dampers.

The **equivalent stiffness** is defined as the ratio of maximum damping force and maximum displacement. This value is frequency dependent and is used in calculation programs that cannot work with velocity proportional damping values.

The **permissible displacement** is the sum of thermal expansion, shock response and operating vibration. Usually permissible displacements are ± 40 mm in horizontal and vertical direction. Dampers with larger displacements are also available.

In addition, dampers can be preset to accommodate larger thermal expansions.

The **operating temperature** is the maximum temperature in the damping fluid during continuous operation.

Depending on the application and temperature range GERB is using different damper designs and damping fluids. We categorize the following types:

- Type **VES** for nuclear facilities according to KTA guideline 3205.3 und TÜV performance specification for aptitude tested, non integral supports of piping systems and components. (Dampers type VRD are identical in construction but will be delivered without tests and documentation).
- Type **RRD** and **RRD..TU** for conventional power plants and chemical facilities.
- Type **RHY** for general industrial applications.
- Type **VD..TU** approved by VO Bezopasnost (Russian Nuclear Regulator) for the protection of pipes and components especially in case of earthquakes.

Pipework dampers type RRD..TU and VD..TU are applicable for operating temperatures between - 30 °C and + 130 °C.

Pipework dampers type VES (VRD) and RRD are supplied with damping fluids for 20 °C, 30 °C, 40 °C, 50 °C, 60 °C and in special cases for 70 °C and 80 °C.

Pipework dampers type RHY are applicable for operating temperatures between - 10 °C and + 40 °C.

Installation of a pipework damper type VES



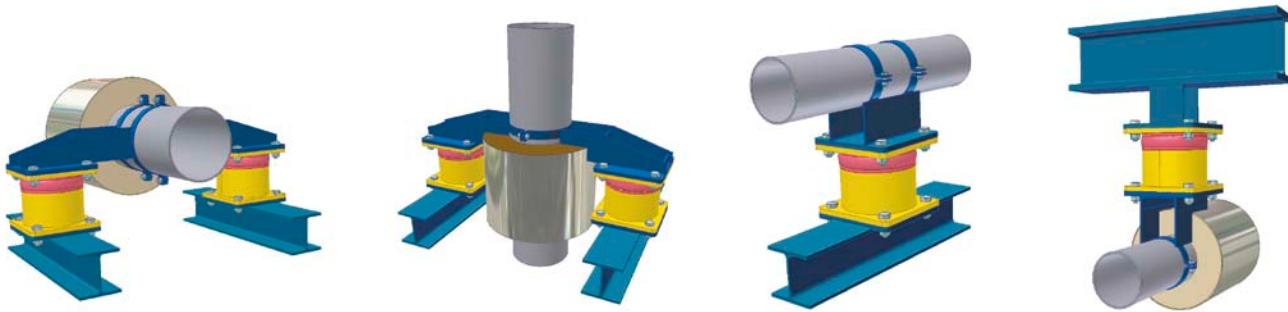

Tips for Pipework Designer

As pipework dampers do not support any static loads they have to be used in combination with other support elements, as spring hangers, gliding bearings and so on.

GERB pipework dampers are most effective when mounted at the locations where the largest displacements will occur. These locations are determined by calculation or general experience.

To dampen several vibration modes, it is better to employ several small dampers instead of one big damper, and to distribute them uniformly over several points of support.

With the aid of modern pipe stress analysis software like ROHR2 and dPipe the effects of viscoelastic dampers can be analysed already during the design stage and the dissipative properties of these elements can be actualized.

GERB pipework dampers can be installed below, above, or next to the pipe. Either the upper part of the damper (damper piston) or the lower part (damper housing) can be connected to the pipe. As the damper develops forces in all directions the load does not need to be in line with the damper axis. However, dampers always have to be transported and installed upright to prevent leakage of the viscous fluid.

GERB will assist you selecting the optimum dampers and finding the best locations for your installation.

Screenshot of a piping program

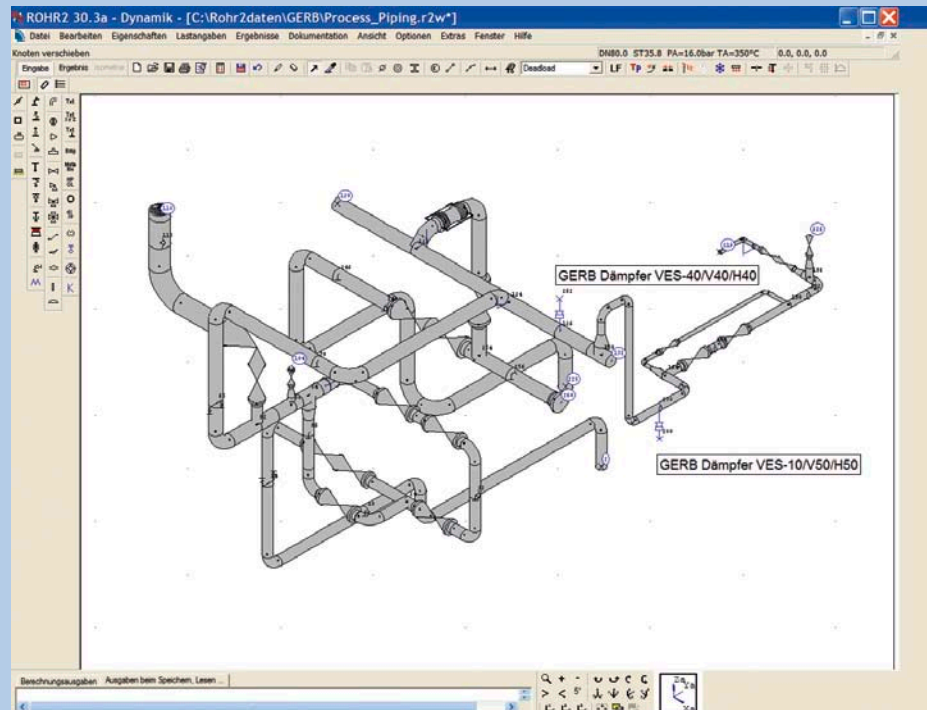

Vibration Control of Piping Systems Reference List (Excerpt)

Country	Project / Plant	Country	Project / Plant
Nuclear Power Plants		Conventional Power Plants	
Argentina	NPP Atucha	Austria	PP Irsching PP Simmering
Armenia	NPP Metzamor	Belgium	PP Rodenhuize
Belgium	NPP Doel	Chile	PP Mejillones
Brazil	NPP Angra	China	PP FuZhou, Fujian PP GuJiao, Shaanxi PP RiZhao, Shandong PP Shantou, Guangdong PP WaiGaoQiao, Shanghai PP YangLiuShu, Tianjin
Bulgaria	NPP Kozloduy	Czech Republic	PP Ledvice
China	NPP Daya Bay NPP Lingao NPP Tianwan	Denmark	PP Avedorevaerket PP Fynsvaerke
Czech Republic	NPP Dukovany NPP Temelin	Egypt	PP Suez
Finland	NPP Loviisa NPP Olkiluoto	Finland	PP Lappeenranta PP Rauhalahhti
Germany	NPP Biblis NPP Brokdorf NPP Brunsbüttel NPP Grohnde NPP Grundremmingen NPP Isar NPP Neckarwestheim NPP Stade	Germany	PP Mannheim PP Niederaussem PP Scholven PP Schwarze Pumpe
Hungary	NPP Paks	Greece	PP Kardía
India	NPP Kudankulam	Hungary	PP Gönyü
Lithuania	NPP Ignalina	India	PP Rihand PP Simhadri PP Talcher
Romania	NPP Cernavoda	Netherlands	PP Maasbracht PP Moerdijk
Russia	NPP Balakovo NPP Kalinin NPP Leningrad	Poland	PP Lagisza
Slovakia	NPP Bohunice NPP Mochovce	Qatar	PP Ras Laffan
Slovenia	NPP Krsko	Slovakia	PP Malzenice
Sweden	NPP Forsmark NPP Oskarshamn NPP Ringhals	Spain	PP Alcudia
Switzerland	NPP Gösgen NPP Leibstadt	Syria	PP Nasserieh PP Zayzoun
USA	NPP Braidwood NPP Calvert's Cliff NPP Farley NPP Riverbend NPP Shearon Harris	Turkey	PP Antalya PP Iskenderun
		United Kingdom	PP Severn
		USA	PP Baltimore PP South California
Chemical Plants		Offshore	
Algeria	Arzew, Ammonia / Urea	Canada	FPSO "SeaRose"
Belgium	BASF Antwerpen ExxonMobil Antwerpen Refinery	Denmark	South Arne Platform
Egypt	Damietta, Ammonia / Urea (EAgrium) Helwan, Ammonia / Urea (Sorfert)	Germany	Mittelplate Platform
Germany	Basell Polyolefine BASF Ludwigshafen Bayer Leverkusen Bayer Uerdingen DOW Stade PCK Refinery Philippsburg	Netherlands	FPSO "Aoka Mizu"
Israel	Carmel Olefins, Haifa	Norway	Draupner Platform (StatoilHydro) Ekofisk (ConocoPhillips) Oseberg Ost Platform (StatoilHydro) Ringhorne (ExxonMobil) Statfjord C Platform (StatoilHydro) Troll A Platform (StatoilHydro)
Kuwait	EQUATE Petrochem. Plant	United Kingdom	Andrew Platform (BP) Curlew Platform (Shell) Dunbar Platform East Brea Platform Jade Platform Murchison Platform Murdoch Platform Ninian South Platform Piper Platform (Talisman) Tartan Platform (Talisman)
Norway	Karstö Processing Plant		
Saudi Arabia	Safco IV Ammonia / Urea (Al-Jubail)		
United Kingdom	Stallingborough TiO2 Plant		
USA	Eastman Chemical		



Installation examples



To prepare a quotation please provide the following information of the piping system:

- ▶ Operating temperature [°C]
- ▶ Temperature range (indoor or outdoor application) [°C]
- ▶ Pipe weight to be dampened [kN]
- ▶ Thermal expansion vertical and horizontal [mm]
- ▶ Type of excitation and frequencies [Hz]
- ▶ Dynamic amplitudes [mm]

GERB Schwingungsisolierungen GmbH & Co. KG

Roedernallee 174-176
13407 Berlin/Germany
 Tel. +49-30-41 91-0
 Fax +49-30-41 91-199

Ruhrallee 311
45136 Essen/Germany
 Tel. +49-201-266 04-0
 Fax +49-201-266 04-40

info@gerb.com
www.gerb.com